

TEBCO

ELECTRIC BICYCLE & TRICYCLE

OWNER'S MANUAL

(03) 9584 3000 | electricbicycle.com.au



TEBCO

ELECTRIC BICYCLE & TRICYCLE

OWNER'S MANUAL

(03) 9584 3000 | electricbicycle.com.au



TEBCO MODELS

SUBURBAN



DISCOVERY



VOYAGER



CROSSTRAIL



EXPLORER



WANDERER



TEBCO MODELS

CARRIER



TRANSPORTER



ECLIPSE



GIACARLO



PIONEER



HURRICANE CONVERSION KIT



CONTENTS

04	TEBCO Models	19	General Information
07	Introduction	27	1. Safety Precautions
08	Safety Information	42	2. How Things Work
09	Power 'Override Switches'	74	3. Maintaining Your Bicycle
10	Display Panel / Trip Computer	75	4. Monthly Service Chart
14	Battery Charging	79	5. Additional Information
16	Adjustment & Maintenance	86	Troubleshooting Chart
17	Safety Precautions	94	Warranty Information
18	Register Your Bicycle		

INTRODUCTION

Thank you for choosing TEBCO

Thank you for choosing your **ELECTRIC BICYCLE** or **ELECTRIC TRICYCLE** from **The Electric Bicycle Co (TEBCO)**. We have created a stylish and serviceable bicycle for your personal transport and enjoyment.

Prior to riding your new **ELECTRIC BICYCLE** or **ELECTRIC TRICYCLE**, please thoroughly read and understand this manual. It is provided for **YOUR** benefit. Should you not understand any part of this manual please consult your retailer.

Our company has developed our **ELECTRIC BICYCLES** and **ELECTRIC TRICYCLES** to strict quality control systems to ISO9001 certification standard.

Our company's aim is to provide customers with high quality, serviceable and affordable personal electric transportation that will give many years of trouble free and enjoyable use, whilst at the same time helping to sustain our fragile environment by utilising clean, green renewable energy.

ATTENTION - SAFETY INFORMATION

- Before you use your **ELECTRIC BICYCLE** or **ELECTRIC TRICYCLE**, please thoroughly read and understand this **Owner's Manual**.
- Once you understand the **Owner's Manual** and know that you are familiar with the bicycle's operation, you are free to ride. Please do not lend your **ELECTRIC BICYCLE** or **ELECTRIC TRICYCLE** to others who are unfamiliar with its operation.
- **NEVER RIDE WITHOUT WEARING A PROPERLY FITTED AND APPROVED BICYCLE HELMET!**
- **ALWAYS ENSURE THAT THE POWER IS TURNED OFF WHEN YOU MOUNT AND DISMOUNT THE BICYCLE!**
- Please be familiar with and observe all local traffic rules of your city / town.
- The **ELECTRIC BICYCLE** and **ELECTRIC TRICYCLE** is designed for single rider use. At no time should you ever carry a pillion passenger as it is illegal to do so.
- Please ride cautiously when riding in wet or slippery conditions or on uneven surfaces.
- This **Owner's Manual** is designed for use only with the **ELECTRIC BICYCLE** or **ELECTRIC TRICYCLE** supplied by **The Electric Bicycle Co.**

POWER ‘OVERRIDE SWITCHES’



Your **ELECTRIC BICYCLE** or **ELECTRIC TRICYCLE** is equipped with 2 power ‘Override Switches’:

- 1.** These are small micro-switches situated within each brake lever.
- 2.** By simply pulling either brake lever on slightly – power is cut to the motor.
- 3.** These are safety switches, which can prevent your bicycle from accidentally ‘starting’ whilst you are stationary.

'KD86' - DISPLAY PANEL / TRIP COMPUTER



'KD86' - PRIMARY FEATURES / FUNCTIONS



- **Power On / OFF Button** – Hold for 2 sec. to Power ON. Hold for 2 sec. to Power OFF.
- **PAS Up Button** – press once to advance to PAS Level 1 - press again to progress up through PAS levels to top PAS level 9.
- **PAS Down Button** - press once to decrease PAS level from top level 9 to bottom level 0.
- **Battery Status Indicator** – indicates amount of charge in battery.
- **PAS Levels** – Displays which level of Pedal Activation is selected.
- **Power Output** - Adjust pedalling effort / motor assistance to conserve battery life. Keeping this level as low as possible will maximise range.
- **Speedometer** - shows your speed when riding.
- **Odometer / Trip Meter** - shows your trip distance or cumulative total distance covered by bicycle.
- **Pedestrian 'Walk' function** – hold down the  Button and the bicycle will auto 'walk' with you at 6kmh.
- **Headlight / Tail-light** – as a SAFETY feature the HEADLIGHT / TAIL-LIGHT will auto flash when the bicycle is powered on. For constant illumination for night riding, hold the  button for 2 seconds to turn ON – hold down  for 2 seconds to turn OFF.

NOTE: To access the full KD86 Manual, visit the [TEBCO website](#) & select 'Download Manual' from model page.

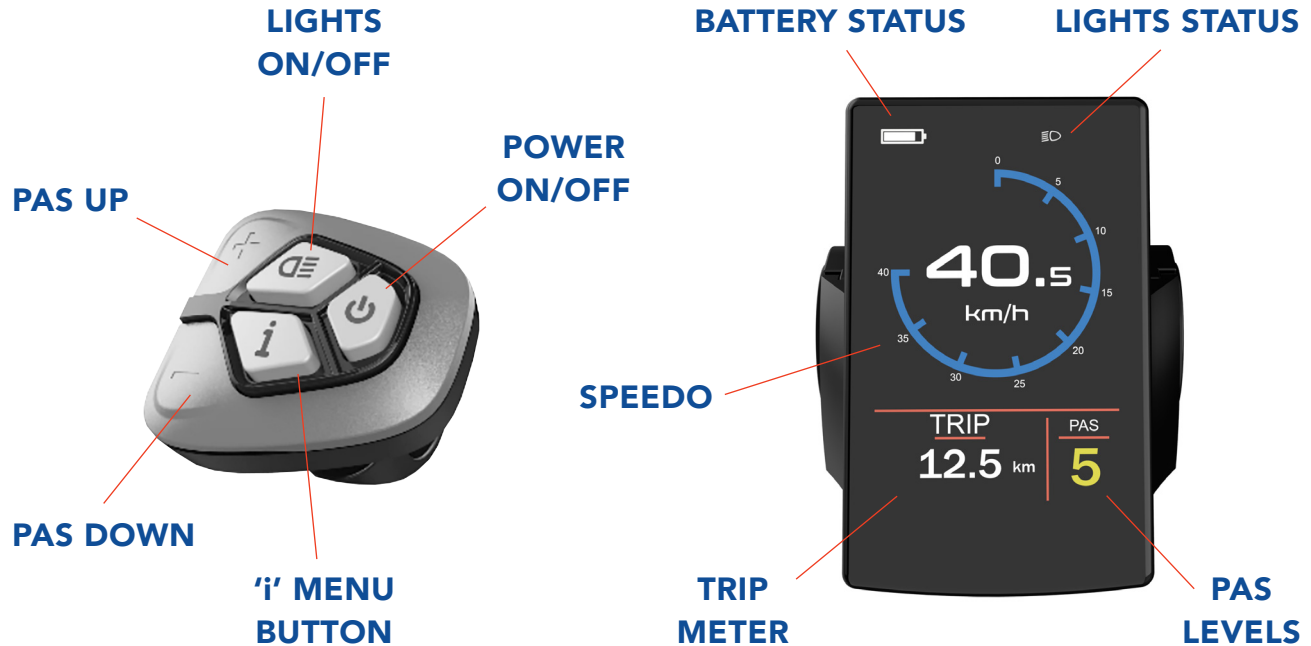
'KD718X' - DISPLAY PANEL / TRIP COMPUTER



‘KD718X’ - PRIMARY FEATURES / FUNCTIONS



- **Power On / OFF Button** – Hold down for 2 seconds to Power ON. Hold Down for 2 seconds to Power OFF.
- **PAS Up Button** – press once to advance to PAS Level 1 - press again to progress up through PAS levels to top PAS level 9.
- **PAS Down Button** - press once to decrease down through PAS levels from top Level 9 to bottom PAS level 0.
- **Battery Status Indicator** – indicates amount of charge in battery.
- **PAS Levels** – Displays which level of Pedal Activation is selected.
- **Speedometer** - shows your speed when riding.
- **Odometer / Trip Meter** - shows your trip distance or cumulative total distance covered by bicycle.
- **Pedestrian ‘Walk’ function** – hold down the  Button and the bicycle will auto ‘walk’ with you at 6kmh.
- **Headlight / Tail-light** – as a SAFETY feature the HEADLIGHT / TAIL-LIGHT will auto flash when the bicycle is powered on. For constant illumination for night riding, hold the  button for 2 seconds to turn ON – hold down  for 2 seconds to turn OFF.

NOTE: To access the full KD718X Manual, visit the [TEBCO website](#) & select ‘Download Manual’ from model page.

'DM07' - DISPLAY PANEL / TRIP COMPUTER



'DM07' - PRIMARY FEATURES / FUNCTIONS

- **Power On / OFF Button** – Hold down for 2 seconds to Power ON. Hold Down for 2 seconds to Power OFF.
- **PAS Up Button** – press once to advance to PAS Level 1 - press again to progress up through PAS levels to top PAS level 9.
- **PAS Down Button** - press once to decrease down through PAS levels from top Level 9 to bottom PAS level 0.
- **Battery Status Indicator** – indicates amount of charge in battery.
- **PAS Levels** – Displays which level of Pedal Activation is selected.
- **Speedometer** - shows your speed when riding.
- **Odometer / Trip Meter** - shows your trip distance or cumulative total distance covered by bicycle.
- **Pedestrian 'Walk' function** – hold down the  Button and the bicycle will auto 'walk' with you at 6kmh.
- **Headlight / Tail-light** – as a SAFETY feature the HEADLIGHT / TAIL-LIGHT will auto flash when the bicycle is powered on. For constant illumination for night riding, hold the  button for 2 seconds to turn ON – hold down  for 2 seconds to turn OFF.

NOTE: To access the full DM07 Manual, visit the [TEBCO website](#) & select 'Download Manual' from model page.

BATTERY CHARGING

1. The battery is the most important part of your **ELECTRIC BICYCLE** or **ELECTRIC TRICYCLE**. To ensure good performance - proper usage and maintenance will maximise battery life.
2. Leaving the batteries discharged for long periods of time should be avoided at all times. Batteries should always be charged ready for riding. If not used for a period of 30 days, batteries should be charged fully.
3. After usage and when bicycle is not in use always be sure to turn Power off. If bicycle left unattended with Power ON for 5 minutes then electric system will auto turn Power OFF.
4. To use battery charger, first insert the plug into charging socket on side of battery. Next plug the charger into a 240V power supply. After the charger is connected properly, turn on 240V AC supply. To disconnect after charging, turn off 240V AC supply, remove plug from 240V socket then remove the plug from the battery socket. **REFER TO BATTERY CHARGER OPERATING INSTRUCTIONS SUPPLIED WITH YOUR CHARGER**
5. When charging the battery, charger status lamp will glow **RED** to indicate '**charging**'. When lamp turns **GREEN** '**charging**' is complete and charger should be turned **OFF**.

BATTERY CHARGING

Charging duration depends on the level of discharge of the battery. Normal charging duration is 5 to 8 hours from flat.

6. Battery performance can be greatly influenced by many factors, including the rider's weight, type of terrain, prevailing climatic conditions, style of riding etc. Be observant of your battery performance and never try to achieve more than your batteries are capable of delivering.
7. If battery needs to be taken out of the Bicycle for charging or bicycle transport - unlock battery lock and remove battery assembly from bicycle or tricycle. To replace battery pack – reverse this operation.

ALWAYS CLOSELY MONITOR BATTERY RE-CHARGING PROCESS – WHEN BATTERY IS RE-CHARGED THEN CHARGER SHOULD BE TURNED OFF.

ADJUSTMENT & MAINTENANCE

General Maintenance

1. As a general rule to ensure longevity and good performance of your bicycle, have it regularly serviced by a qualified and experienced bicycle mechanic.
2. There is no specific maintenance required on your electrical components. Simply charge your batteries after each ride to ensure longest possible life.
3. Adjustment of the height of saddle – Loosen quick release on seat tube and adjust saddle to a suitable height. The raised height of the saddle cannot exceed the height marked with minimum insertion mark on saddle stem.

4. Brakes and their adjustment are standard to the bicycle industry. Be sure to keep brakes properly adjusted always.
5. Regular checking of spoke tension and wheel alignment can also ensure maximum performance of your bicycle.

Tyre Pressure

1. It is most important for the continued effective operation of your bicycle that you maintain the correct tyre inflation.
2. Please confirm the correct pressure on the side wall of your tyre. This will be between 30psi and 65psi.

SAFETY PRECAUTIONS

- 1.** Always make sure Power is **OFF** when you mount or dismount your bicycle. Only Power **ON** once you are safely seated on your bicycle.
- 2.** Never try to **RACE** your bicycle or ride at high speeds for long periods of time.
- 3.** Never try to climb hills that are too steep and that will force the bicycle to slow below 10kms. Best performance is achieved on flat or gently rising terrain.
- 4.** When either the left or right brake lever is engaged, a micro switch will cut power to motor. Should either of these switches fail to work at any time please contact your supplier immediately.
- 5.** In wet or rainy weather, the bicycle should be ridden slowly and with much greater care.

REGISTER YOUR TEBCO BICYCLE / TRICYCLE

To register your ELECTRIC BICYCLE / TRICYCLE, visit:

www.electricbicycle.com.au

Click TAB **'REGISTER'**

at top right of home page.

Accurately complete ALL fields

To Register your ELECTRIC BICYCLE / TRICYCLE.

GENERAL INFORMATION

Note on the Following Sections

Many of the following Sections of this Manual are indeed irrelevant to your **ELECTRIC BICYCLE** or **ELECTRIC TRICYCLE**.

However this is the format that Australian Standards mandate that we must follow.

Please read the Manual in its entirety – take particular note of Sections that are specific to the **ELECTRIC BICYCLE** or **ELECTRIC TRICYCLE**.

Acknowledgments

This Manual has been developed by BIA Ltd.

Illustrations reproduced courtesy of BIA member Companies.

The information contained in this Manual complies with relevant Australian Standards at the time of printing. This Manual may not be reproduced without the express and written permission of BIA Ltd.

Bicycle Industries Australia Ltd. ABN 84 094 666 538

*Bicycle Industry of Australia on the Web:
www.bikeoz.com.au*

YOU SHOULD READ THIS MANUAL

Your bicycle is legally a vehicle. It can be ridden on roads mixing with other traffic. You need to know about certain legal and common sense requirements for the enjoyable, safe and trouble free use of your bicycle.

OWNER'S INFORMATION AND RESPONSIBILITY

To reduce the risk of serious personal injury, you should read the instructions in this manual carefully.

Your bicycle has been supplied fully assembled and adjusted ready for use. This manual is not an 'assembly instruction'. If your bicycle has been supplied in a form not ready for use you must

obtain "assembly instructions" from your supplier.

Return your bicycle for an initial service by your bicycle retailer to ensure correct functions of components. The owner or main rider is then responsible for normal maintenance of the bicycle to keep it in good operating condition.

Know how to operate all standard and accessory equipment on the bicycle.



ATTENTION

There are warnings throughout this manual. Follow all warning instructions. Don't risk injury, mechanical failure or damage.

Ensure that anyone who uses the bicycle has been fully instructed in the operation of bicycle functions.

Your bicycle conforms to relevant Australian Standards. Other local regulations may apply. Check with your bicycle retailer.

Many bicycle product manufacturers and suppliers provide additional information on Web sites. The Bicycle Industry in Australia Web site includes

many useful links and other information at:
www.bikeoz.com.au

The Cycling Promotion Fund offers helpful hints and links at: **www.cyclingpromotion.com.au**

WHAT KIND OF BICYCLE IS IT?

Bicycles can be broadly categorised into 4 types:

- Road or Touring
- Mountain or Off Road
- Cross, Hybrid, City or Comfort
- BMX or Freestyle

Bicycles for younger riders use are generally scaled down versions of adult bicycles including the step through design. Other bicycles include tandems, recumbents and folding bicycles. Which type is your new bicycle?

ROAD OR TOURING

Typically has narrow tyres and drop handlebar.

Variations include bicycles suited for touring, commuting, sports, and recreational riding.

MOUNTAIN OR OFF ROAD

The Mountain Bicycle is designed to give the rider maximum control and durability on a wide variety of harsh terrain. Everything about the Mountain Bicycle is more rugged. Its frame geometry provides maximum ground clearance and allows you to quickly and easily shift your weight to change the balance of the bicycle as terrain conditions demand.



WARNING

Not all Mountain type bicycles are intended for off road or competition use. Check specifications and technical advice from your bicycle retailer before use.

CROSS, HYBRID, CITY OR COMFORT

Usually something of a mixture of characteristics of the Road and Mountain types but may include evolving frame shapes and components. Suited for general purpose riding.

BMX

BMX, are general purpose bicycles for younger riders. The BMX type Bicycle is a versatile

machine usually of 20"(510mm) or less sized wheels with wide section tyres, ideal for general purpose use by younger riders.

FREESTYLE

Modelled on a trick riding style machine, featuring 360 degree revolving handlebar/fork assembly, axle pegs and wide profile tyres. Using a freestyle type bicycle for trick or competition riding may void warranty.



WARNING

General purpose Freestyle and BMX bicycles are not designed for stunting, racing or competition use

POWER ASSISTED BICYCLES

Have characteristics and equipment which may require special instruction, adjustment, care and maintenance. Read carefully all instruction manuals. Ask your bicycle retailer for advice on maintenance, adjustments and repair.

Unauthorised work may limit or void the warranty.

FOLDING BICYCLES

Designed for easy storage. May require special instruction before use. Ensure that all locking devices are correctly secured before riding a Folding bicycle.

WHAT IS IT CALLED?

Although bicycle components vary in design, weight and method of use, basically all bicycles are the same.

A bicycle is made up of a frame, wheels, drive train, brakes, stem, handle bars and saddle. Frames must show a makers ID label.

Familiarise yourself with the bicycle's terminology; it will make basic maintenance instructions much easier to follow.

TYPICAL PARTS OF A BICYCLE

NOTE: Not all components nor all bicycle types are shown.

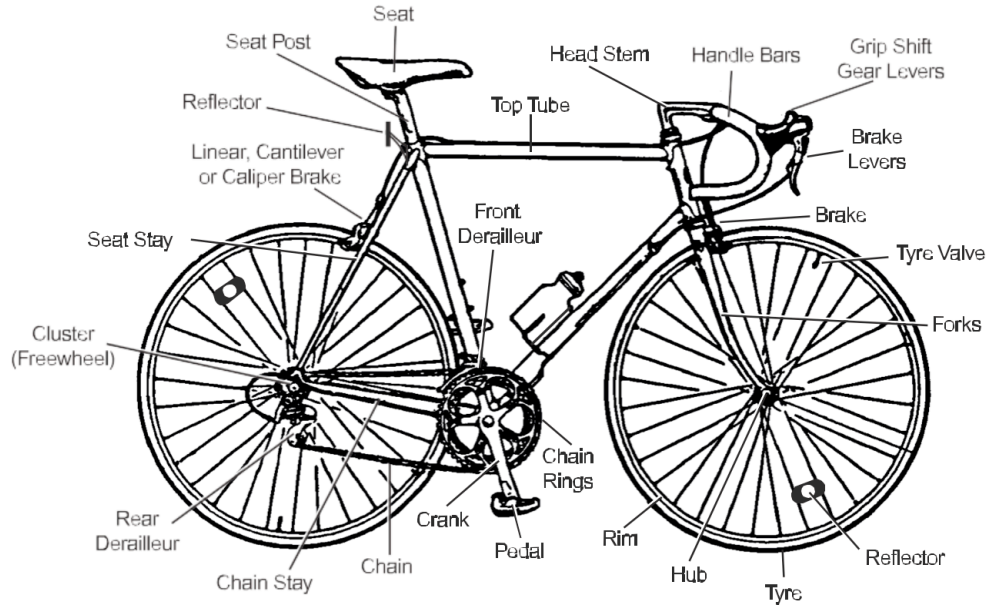



WARNING

Handlebar handgrips or tube-end plugs should be replaced if damaged. Unprotected tube-ends can cause injury. Bicycles used by children should especially be checked to ensure bar end handgrips are in good condition.

FOR ALL TYPES

Where a suspension unit, disk and / or hydraulic brake units, multi-gear hub, electric gear changing system, etc, are fitted, consult manufacturers specification and warranty documents. For correct selection and repair advice, ask your bicycle retailer. Unauthorised work may limit or void a product warranty.

1. SAFETY PRECAUTIONS

1.1 FITTING YOUR BICYCLE FOR A SAFE RIDE

To ride safely and comfortably a bicycle and its equipment must be matched properly to the size and skills of the rider.

FITTING FOR LEG LENGTH

To ride safely and comfortably a bicycle and its equipment must be matched properly to the size and skills of the rider.

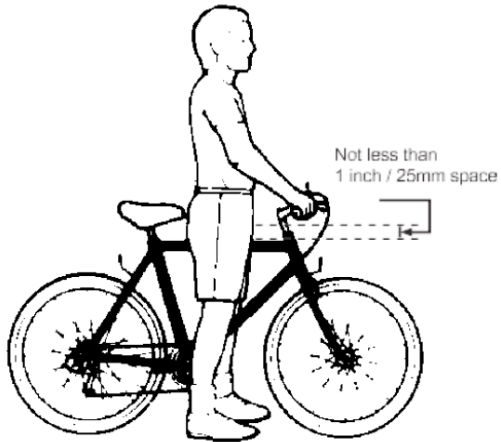

FRAME SIZE	RIDER LEG LENGTH
14.5"	25 - 26"
15"	26 - 27"
16"	27 - 28"
17"	28 - 30"
18"	29 - 31"
19"	30 - 32"
20"	31 - 33"
21"	32 - 34"
22"	33 - 35"
23"	34 - 36"
24"	35 - 37"
25"	36 - 38"

MAKE SURE THE BICYCLE FITS

A bicycle that is too big or too small for the rider is hard to control and can be uncomfortable. If your bicycle does not fit properly, you may lose control and fall.

SADDLE HEIGHT

To ride comfortably and pedal efficiently, it's very important to have the saddle at the correct height. Your leg length determines the correct saddle height. The saddle is at the correct height for you when, while seated on the saddle, your knee is slightly bent when the crank is at the maximum down stroke (pedal is closest to the ground).

To adjust the saddle height, loosen the **seat binder bolt** (A) or the **quick release** (B) and move

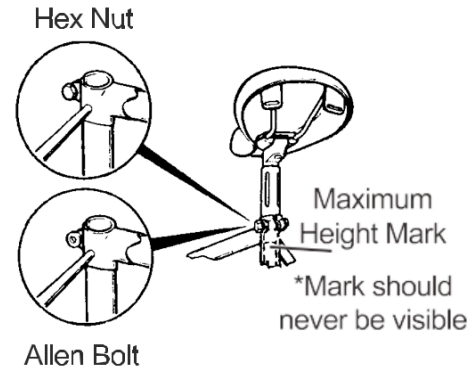
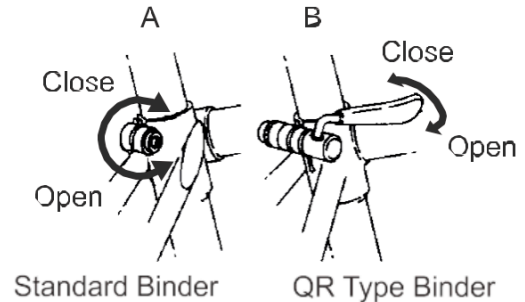



WARNING

Do not replace the seat post with a post which is: A) not of the same diameter or B) longer than the original. Either will void the warranty and could lead to seat post failure, loss of rider control and injury.

the seat post up or down as required. Make sure that the saddle is parallel to the top tube of the bicycle. Retighten the seat post tight enough so that you cannot twist the saddle out of alignment.

A loose seat post will allow the saddle to turn or slip and may cause you to lose control and fall. Therefore:

1. Ask your bicycle retailer to help you make sure you know how to correctly clamp your seat post.
2. Before you ride the bicycle, first check that the seat post is securely clamped.

Under no circumstances should the seat post project from the frame beyond its 'Minimum Insertion' or 'Maximum Extension' mark.



WARNING

Under no circumstances should the head stem be retightened with its 'Minimum Insertion' or 'Maximum Extension' mark visible.

HANDLEBAR HEIGHT AND ANGLE

After you have set the saddle height and tilt, adjust the handlebar for a safe and comfortable ride.

Ask your bicycle retailer for advice.

'Threadless' headset. DO NOT over tighten the two securing bolts. If unsure, consult your bicycle retailers.

If the front brake cable is attached to the handlebar stem moving the stem up or down will require a readjustment of the brake. If in doubt, ask your bicycle retailer to make the adjustment.



WARNING

Front wheel brake lever must be mounted on the **right** hand side; rear brake lever on the **left** hand side.

CONTROLS POSITION ADJUSTMENT

The brake and shifting controls on your bicycle are positioned where they work best for most riders. The angle of the controls and the position on the handlebars can be changed. Ask your bicycle retailer to make the adjustments for you.

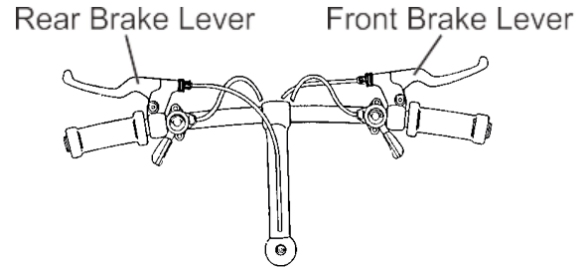

HAND BRAKE LEVER 'REACH'

Many bicycles have brake levers which can be adjusted for 'reach'. If you have small hands and find it difficult to squeeze the brake levers, your bicycle retailer can either adjust the reach or fit shorter reach brake levers.

1.2 SAFETY CHECK BEFORE RIDING YOUR BICYCLE

- Check and tighten any loose nuts, bolts and straps. If you're not sure, ask your bicycle retailer to check.
- Tyres correctly inflated? Check by pushing down with your thumb on the top of the tyre. The tyre should depress slightly.

Compare to how it feels when you know the tyres are correctly inflated.

Replace damaged tyres before they puncture.

- **Wheels** true? Spin each wheel and check for brake clearance and side-to-side wobble. If a wheel wobbles or hits the brake pads, take the bicycle to your bicycle retailer.
- **Brakes:** Check that the brakes operate effectively.

QUICK RELEASES

Are the front wheel, rear wheel and seat post quick releases properly adjusted and in the locked position? Check all quick release mechanisms are correctly and securely closed.

CHECK LIGHTS AND REFLECTORS

- Working
- Correctly aligned

HANDLEBAR AND SADDLE

- Are the handlebar and saddle system: horizontal? Tight enough so they won't twist? handlebars secure, good condition? Handle bar ends plugged?

- Is a bell fitted and working?

Any broken or worn parts should be replaced before the bicycle is used.

Certain activities may damage your bicycle and result in serious personal injury. Take these precautions:

- Avoid jumping kerbs
- Avoid potholes and gratings
- Avoid stunt riding and jumping



WARNING

Do not remove protective safety equipment fitted to your bicycle, including handlebar end covers or plugs; reflectors fitted to frame, wheels and pedals; reflector mount brackets (where cantilever brakes are fitted); front chain ring guard; rear wheel spoke protector (right hand side); chain guard where fitted; warning stickers affixed to frame.



NOTE

A replacement fork must be the same length and maintain the same rake and trail characteristics as the original. Ask your bicycle retailer for advice.

1.3 SAFETY EQUIPMENT AND SENSIBLE RIDING

As a road user you have responsibility for your own safety and the safety of others.

You need to know:

- the road rules
- how to ride safely

YOUR BICYCLE

- Check your bicycle before you use it. (Use the safety check 1.2 including the adjustments).
- Know how to work all bicycle controls.
- For riding in low light and night conditions, fit your bicycle with appropriate front and rear lamps.



WARNING

Check reflectors and mounting brackets regularly to make sure that they are clean, straight, unbroken and securely mounted. Equip your bicycle with lights: white front and red rear. Riding in low light or at night time without reflectors and lights is extremely dangerous.

YOUR CLOTHING

- Wear a correctly fitted and fastened Approved helmet.
- **Be seen:**
 - Wear brightly coloured clothes - yellow, green and orange are best for day, reflective tape improves the conspicuity of riders at night.
 - Wear shoes, not thongs or ride with bare feet.

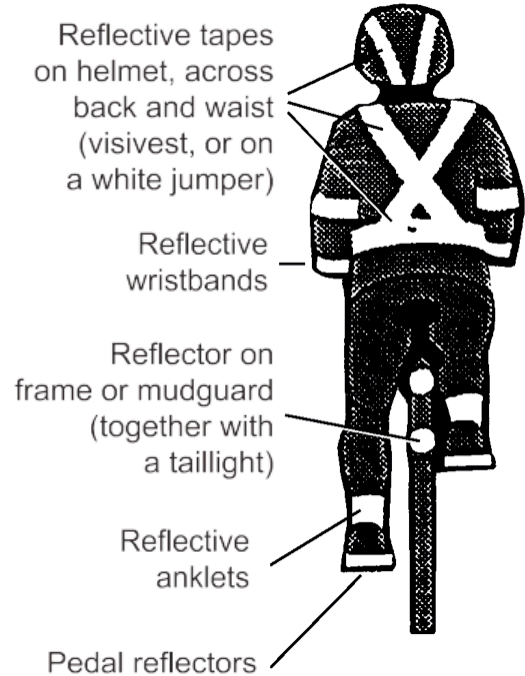



WARNING

Always wear a correctly fitted and fastened helmet when riding your bicycle.

BE ALERT

- Obey all road rules
- Watch out for other road and pathway users.
- Adapt your riding to suit the conditions.

Correct Fit



Incorrect Fit



HOOK TURN

This manoeuvre can assist in safer right hand turns at intersections.

There are three steps to the hook turn:

1. Stay on the left, go straight ahead and cross the intersection. Stop on the other side of the intersection.
2. Swing your bike around to face the new direction.
3. Obey any traffic lights and complete your turn when it is safe.

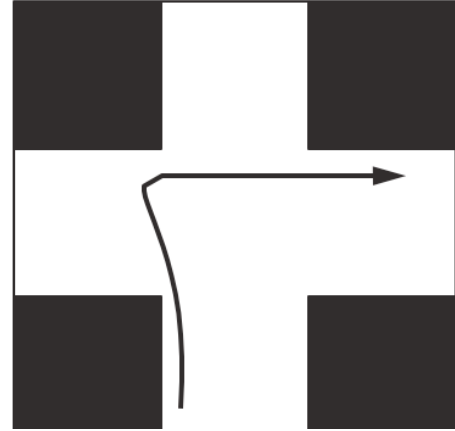

CARRYING LOADS

- Use correctly fitted carriers, racks, panniers or a back pack for parcels.

RIDING IN THE WET

Wet weather affects visibility for all road users.

It is harder for you, and other vehicles, to stop in the wet. Allow more distance to brake.

RIDING IN LOW LIGHT

Riding when light levels are low - use lamps and reflectors, wear bright reflective clothing.

BE RESPONSIBLE

Follow the road rules. Use common sense. If riding in remote areas:

- go with a friend
- leave details of route and return time with a responsible person
- tell them when you get back!

PARENTS

Most cycling incidents involve small children and teenagers.

Make sure:

- The bicycle is in good working order
- **The rider knows:**
 - How to use the controls
 - The road rules
- Clothing, helmet, lighting are appropriate for the bicycle trips undertaken.

QUICK SAFETY SUMMARY

- Obey all traffic laws
- Be predictable
- Be alert
- Use reliable safety equipment
- Use the bicycle for the manufacturer's recommended purpose
- Adjust riding to traffic and weather conditions
- Wear appropriate clothing
- Follow the manufacturer's instructions for any adjustments

2. HOW THINGS WORK

It's important for your enjoyment and safety to know how things work on your bicycle.

QUICK RELEASE (QR) MECHANISM

The bicycle quick release allows wheel removal without the need for tools.

It is essential that you:

- Ask your bicycle retailer to show you how to install and remove your wheels safely.
- Use the correct technique for clamping your wheel in place with a quick release.
- Before you ride the bicycle, check that each wheel is securely clamped.



WARNING

Riding with an improperly adjusted wheel quick release can allow the wheel to wobble or disengage from the bicycle, causing damage to the bicycle and risk of a crash.

The Wheel Quick Release is a long bolt called a skewer, with a lever on one end and a nut on the other, the wheel quick release uses a cam action to clamp a bicycle wheel in place.

ADJUSTING THE QUICK RELEASE MECHANISM

The wheel hub is clamped in place by the force of the Quick Release lever cam pushing against one dropout and pulling the adjusting nut using the skewer against the other dropout.

Turning the adjusting nut **CLOCKWISE** will **INCREASE** the clamping strength of the lever.

Turning the adjusting nut **ANTI-CLOCKWISE** will **DECREASE** the clamping strength of the lever.

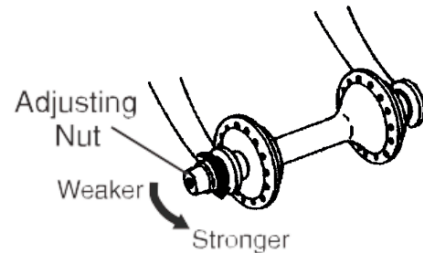
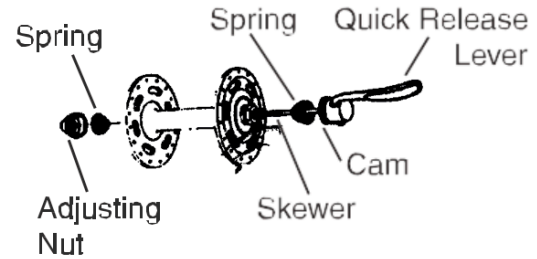

The full force of the cam action is needed to clamp the wheel securely. You cannot secure the quick release mechanism by twisting the adjusting nut. Never use the QR lever to wind up the mechanism. Tighten or loosen using the adjusting nut with the QR lever in the open position.

FRONT WHEEL SECONDARY RETENTION DEVICES

Some bicycles have front forks which use a secondary wheel retention device to keep the wheel from disengaging if the axle nuts loosen.

Some bicycle front forks have a shaped lug which acts to keep the wheel from disengaging if the axle nuts are loosened. To remove the wheel the axle nuts (or quick release mechanism) must be backed off far enough for the wheel to be removed.

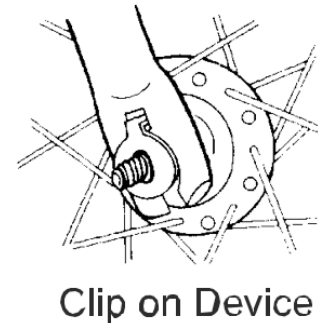
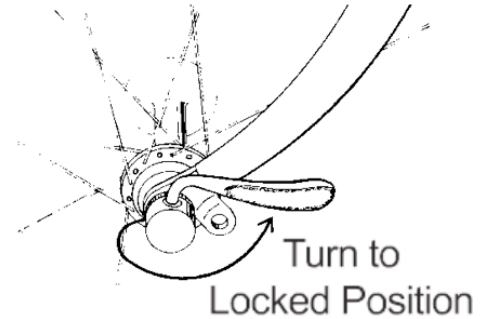



WARNING

Removing or disabling the secondary retention device is extremely dangerous, may void the warranty, and can lead to serious injury.

REMOVING THE FRONT WHEEL

Cantilever and Linear brakes

Release the Brake Quick Release. (This will allow the brakes to be opened to let the tyre pass between the brake blocks).

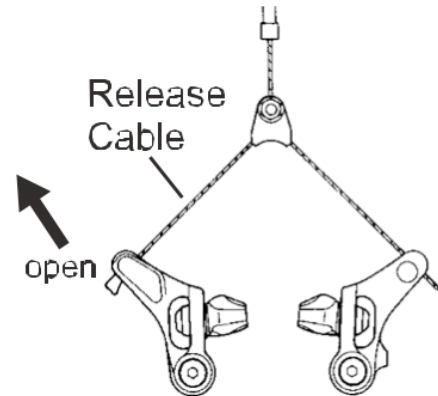

Side pull brakes

Release the Brake Quick Release. (This will allow the brakes to be opened to let the tyre pass between the brake blocks).

Move the Wheel Quick Release Lever to the open position.

If your bicycle is fitted with secondary retention devices unwind the Quick Release Lever enough to allow the wheel to be removed.

If your front wheel is fitted with axle nuts instead of a Quick Release mechanism, use a spanner of the correct size to fit the axle nuts.

- Unwind the axle nut sufficiently to allow the secondary retention devices to release.

- Hold the front of the bicycle 30mm to 50mm off the ground to allow the wheel to be removed.

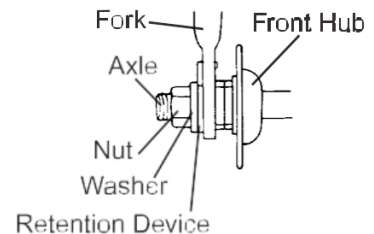
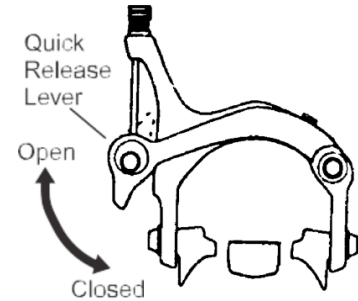

INSTALLATION OF THE FRONT WHEEL

The installation is the reverse procedure to Removing the Front Wheel, except:

- Make sure the wheel axle is correctly positioned in the fork (see diagram).
- Position the Quick Release parallel to the front fork when it is in the CLOSE position. This will prevent the lever being knocked open whilst riding.
- The Quick Release Lever is positioned on the left hand side.

Axle correctly seated
in dropout



QR lever
in Closed
position

ADJUSTMENT NOTES

If the Quick Release Lever can be easily pushed to the CLOSE position, the clamping strength is insufficient.

- Return the lever to a position at right angles to the fork.
- Turn the Adjusting Nut clockwise to increase the clamping strength.
- Push the lever back to the CLOSE position to check the clamping strength.
- You will need a reasonable amount of force to CLOSE the lever to ensure the adjustment is correct.

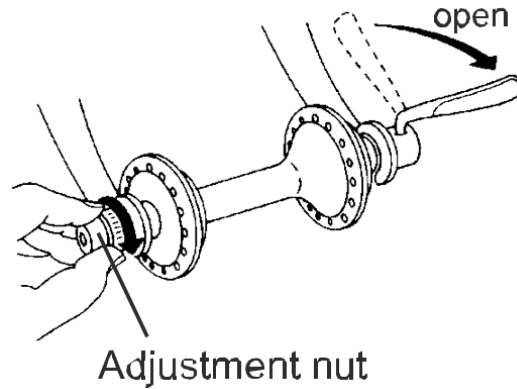



NOTE

If you are not sure of any of these steps or how the quick release mechanism operates ask your bicycle retailer.

REMOVING THE REAR WHEEL

- Set the rear gear lever so that the chain can be moved to the smallest cog.
- Release the Brake Quick Release (see Removing the Front Wheel)
- If fitted with axle nuts, use the correct spanner to loosen the axle nuts enough to allow the wheel to be removed.
- If fitted with a Quick Release Lever, move the lever into the OPEN position. This allows the wheel to be removed.
- Lift the bike off the ground 30-50mm, push the wheel forward and down until it comes out of the dropouts.

INSTALLING THE REAR WHEEL

Installation is the reverse procedure of removing the rear wheel. NOTE: Make sure that the chain is on the small cog as you position the rear wheel in the dropouts.

Check that you have the correct clamping pressure (Quick Release Lever).

If you have axle nuts make sure they are tightened correctly.

Ensure that the Quick Release Lever is positioned as shown to prevent the lever from releasing whilst riding.

When repositioning the wheel in the frame make sure that it is centrally located to prevent 'rubbing' of the wheel on the frame.

QR lever
in Closed
position

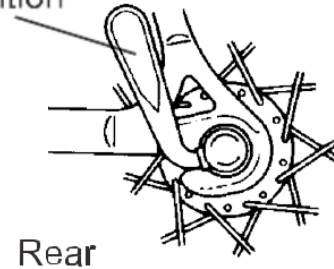

WARNING

Failure to properly
reinstall a wheel may
result in a crash.

SEAT POST QUICK RELEASE

Many bicycles are equipped with quick release seat post clamps. The seat post quick release clamps work exactly like the Wheel Quick Release.

See Adjusting the Quick Release Mechanism.

Follow the steps described to adjust the height of your seat post.

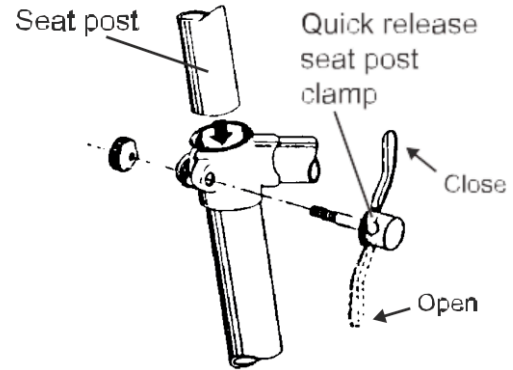

WARNING

The full force of the cam action is needed to clamp the seat post securely.

OTHER SEAT POST FIXINGS

- An Allen Key bolt or nut is used. You must use the correct type of tool to make adjustments.
- The Seat Post must be inserted in the seat tube to at least the minimum insertion point.
- Ensure indexing lug on the seat post clamp bolt is correctly engaged in the seat tube clamp.

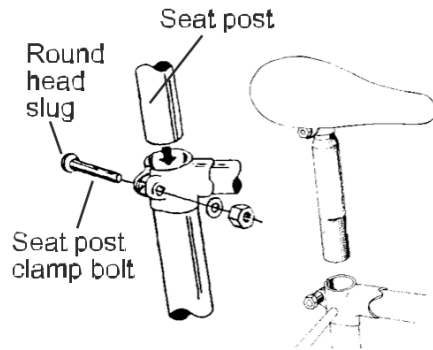

BRAKES

The braking action of a bicycle is a function of friction between brake surfaces, usually the brake blocks and the wheel rims.

- Keep your wheel rims and brake blocks clean and free of lubricants, waxes or polishes.
- Make sure that your hands can reach and squeeze the brake levers comfortably.
- Most bicycles are fitted with front and rear hand brake levers and these are attached to either CANTILEVER CALIPERS, SIDE PULL CALIPERS, DISK or LINEAR BRAKES.
- When replacing both brake cables check that the left hand cable is fitted to the rear brake when looking from the riding position.

- To adjust chain tension on a bicycle fitted with a back pedal brake or internally geared hub with a single freewheel cog, the back wheel must be moved forward or backward in the dropouts. Loosen the axle nuts and brake arm clip. Allow 10 -12mm of up / down chain movement halfway between chainring (front) and cog (rear). Re-tighten nuts and brake arm clip.
- For back pedal brakes: check that the brake arm clip is securely attached to the chain stay.

Note: Most brakes have some form of quick release mechanism to allow the brake shoes to clear the tyre when a wheel is removed or reinstalled. When the brake quick release is in the open position, the brake will not operate. Ask your bicycle retailer for help. Make sure you understand the way the brake quick release works on your bicycle.



LINEAR

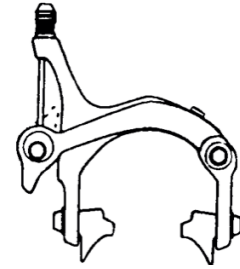

SIDE PULL

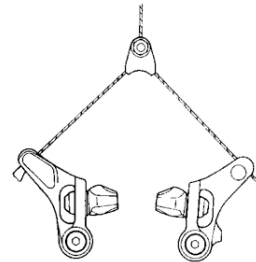

CANTILEVER



DISK



WARNING

Careless use of the front brake first can cause a crash.

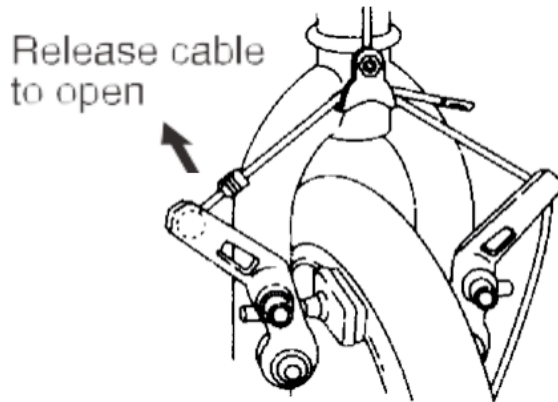

BRAKE ADJUSTMENT

CANTILEVER TYPE BRAKES

- You should have approximately 2mm clearance between the brake blocks and the wheel rim.
- To adjust the brakes, on the brake lever turn the barrel adjuster **CLOCKWISE** to loosen the brake. Move the adjuster **ANTI-CLOCKWISE** to tighten the brake. Turn the lock ring located below the barrel until it stops to set your adjustments.
- If your brakes shudder/squeal you need to check the toe in/out alignment of the brake blocks. The leading edge of the block should be 0.5 - 1mm, closer to the wheel rim than the trailing edge.

- To centre the brake arms, loosen the cable carrier nut, slide the cable carrier up or down until it centres the brake blocks (so there is an even gap on either side of the rim).
- Retighten the cable carrier nut.
- Spin the wheel to ensure the brake blocks, do not rub on the wheel rim.
- Use the springforce adjustment screw to change toe in/out position.
- Using an Allen key turn CLOCKWISE to move the brake pad trailing edge out. Turn the Allen key ANTI- CLOCKWISE to move the brake pad trailing edge in.

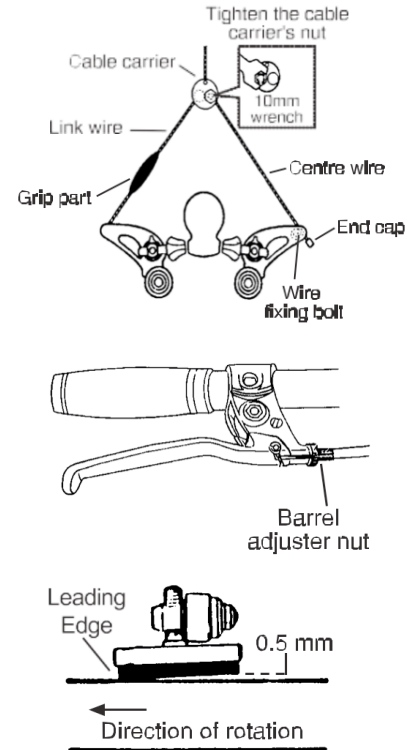

LINEAR TYPE BRAKES

- A Linear brake arm might have a post type brake block (as for a Cantilever brake) or a block which can only be adjusted for toe-in and block-to-rim alignment, in which case brake block-to-rim clearance is adjusted by changing the brake cable length at the brake arm or at the brake lever cable adjuster. Ask your bicycle retailer how to make the correct adjustment.
- To release a Linear brake press the brake arms together and unclip the cable lead unit (curved metal tube) from the pivotted metal stirrup. The brake cable remains attached to the opposite brake arm. If the cable lead unit and cone shaped ferrule cannot be unclipped either slacken the cable at the brake lever (using the cable adjuster) or release the cable end which is attached to the brake arm.
- **NOTE:** Allow sufficient 'travel' in the brake lever and cable to enable the curved cable lead tube to be unclipped from the stirrup.
- To reset the cable lead tube press the brake arms together and re-clip into the pivotted metal stirrup.
- **IMPORTANT: Ensure the cone shaped ferrule is fully seated in the stirrup. Ensure the protective flexible bellows or accordion-like cable protector between the brake arm and the stirrup is correctly located.**

- Brake lever 'travel' can be adjusted for ease of use by a child or anyone with small hands by means of the adjuster screw usually located on the body of the brake lever.
- **NOTE:** a brake lever with too little 'travel' before hitting the handlebar may cause a linear brake to 'lock up' if the lever is pulled on hard. Longer lever 'travel' allows more progressive and better controlled braking. Adjust to suit your riding style, or ask your bicycle retailer to assist you make the correct adjustment.
- **NOTE:** all components of a linear brake must be compatible. Do not mix brake types.
- The brake lever for a linear brake is not designed to work with other types.

SIDE PULL TYPE BRAKES (ROAD BICYCLES)

When your side pull brake caliper is properly adjusted, you should have between 1-2mm gap between the brake block and the wheel rim.

- To centre the brake caliper use the centering adjustment screw to centre the brakes.
- Turn the screw **CLOCKWISE** to move the caliper to the right.
- Turn the screw **ANTI-CLOCKWISE** to move the caliper to the left.
- To set the gap between the blocks and the wheel rim use the Cable Adjustment Bolt.

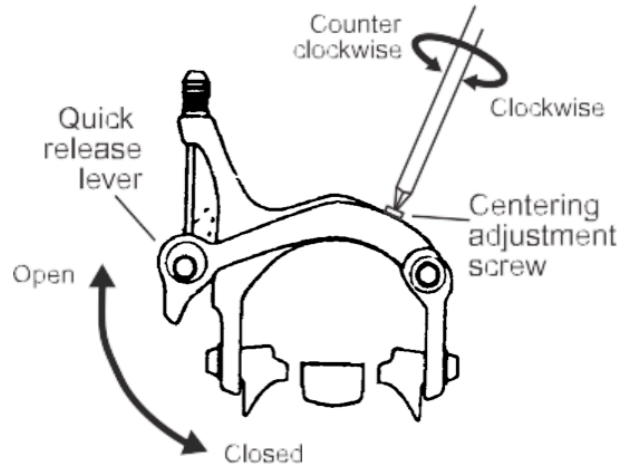

- Turn the Adjustment Bolt CLOCKWISE to move the brake block away from the rim.
- Turn the Adjustment Bolt ANTI-CLOCKWISE to move the brake block towards the rim.
- Tighten the Cable Adjustment Bolt Lock Nut in a CLOCKWISE direction to set your adjustment.
- If your brakes shudder/squeal you need to adjust the toe in / out.
- As you need to realign the caliper arms to overcome this problem, your dealer should make this adjustment to your bike.

Cable adjustment bolt

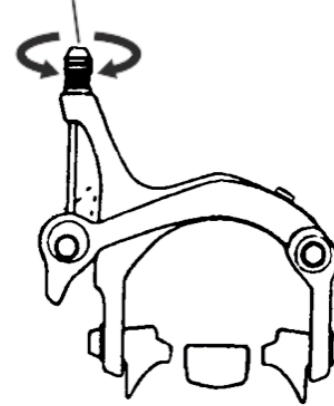

DISK STYLE BRAKES

The distinctive feature of disk brakes is the actual braking disk that is fixed to the wheel and the caliper unit attached to the front fork or rear wheel frame.

The brake is activated either by a cable or hydraulic system. Disk brake systems require special care of the disk itself, which can even be damaged by some bicycle parking racks.

Hydraulic systems may require special tools and adjustments. If in doubt about any adjustments or maintenance consult your bicycle retailer or the manufacturer's manual or specifications data. Some brands provide technical data on their websites.

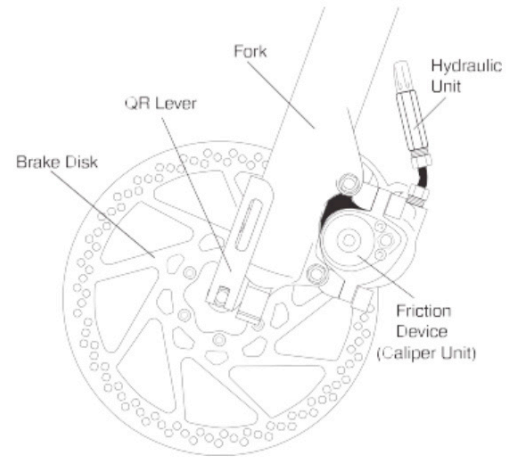

Disk Style Brake System

The brake Quick Release mechanisms are used to open the brake arm to assist in the removal / installation of wheels. The brakes will not function if the Quick Release is left open. **DISK STYLE**



WARNING

Failure to properly maintain your brake system may result in a crash.



WARNING

Failure to firmly secure the Brake Quick Release Mechanism may cause a crash

THE DERAILLEUR GEAR SYSTEM

The gear system on your bicycle consists of:

- A rear cluster (freewheel) which is attached to the rear wheel.
- A rear derailleur which moves the chain across the cluster to change the gear ratio.
- A front derailleur which moves the chain between the front chain rings to change the gear ratio.
- Gear levers which, when moved, change the gears.
- Control cables which attach the gear levers to both the front and rear derailleurs.
- A chain.

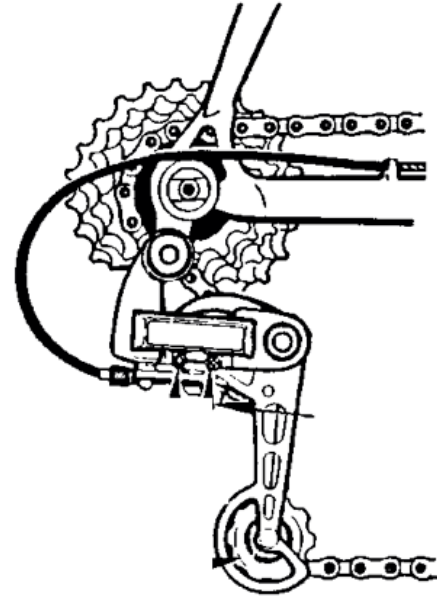

INTERNAL GEARED HUB

If your bicycle is fitted with a multi speed internal geared rear hub it may require special instruction for correct use, adjustment, care and maintenance. Read carefully the instruction manual supplied with your bicycle.

Ask your bicycle retailer for advice on use and maintenance of an internal geared hub.

NOTE: Unauthorised work may limit or void the warranty.

The purpose of derailleurs is to move from one sprocket to another to allow for a variety of gear ratios.

These ratios allow the rider to maintain a constant pedal revolution in a variety of road and speed conditions.

Ask your bicycle retailer for advice.

SHIFTING GEARS

Identify your gear levers from the diagrams.

Mountain / Cross bicycles have handlebar mounted shifters.

Road bikes use various types of shifters, these can include Integrated Brake and Gear Levers, rotating handlebar 'grip shift' systems or other variants. Ask your bicycle retailer to explain the gear changing procedure. Practice changing gears to gain confidence.

For smooth operation of all types of levers you must be pedalling forwards when changing gears.

NOTE: Some bicycles have gear levers mounted on the down tube (see diagram) of the frame. Using this type of mounting requires practice.

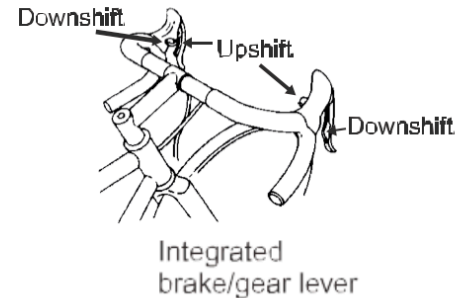
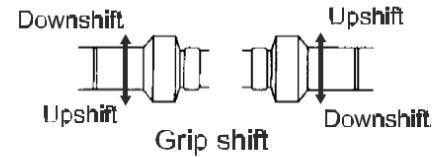
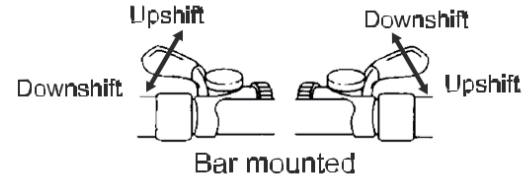



WARNING

Peddalling backwards whilst changing gears can jam the chain causing damage to your bicycle and / or a crash.

Shifter Levers
on Down Tube

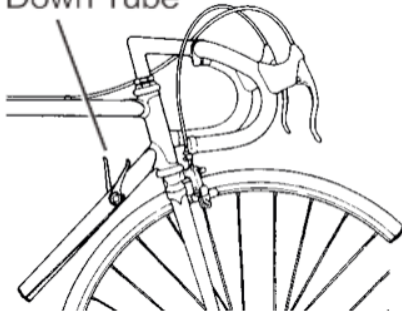

FRICITION GEAR SHIFT LEVERS

Friction levers are 'stopless' and hold the derailleur in place with simple force (tension). The amount of friction can be adjusted by means of the screw on top of the lever assembly.

If derailleur gears on your bicycle are indexed, each time you move the gear lever one click the derailleur travels a set distance to engage the next gear. This enables you easier and more accurate gear changing.



THE GEAR SHIFT PRINCIPLE

The **right hand** lever operates the rear gears. The **left hand** lever operates the **front chain ring shifter**.

When shifting through a wide range of gears, you may notice a noise as a result of the chain rubbing on the inside of the front derailleur cage.

This noise can be eliminated by moving the gear lever (friction systems) or adjusting the gear cable (indexing systems.)



WARNING

Avoid riding with the chain on both the largest front chain ring and the largest rear cog, smallest rear cog and small chain ring. This puts excessive strain on the chain and can damage derailleur parts

Practice changing to a lower gear before stopping. This will assist easier starting at take-off.

As you gain more experience with your gear ratios you will be able to select the most suitable gear for the terrain and weather conditions.

NOTE: Your bicycle retailer will be able to assist you if you are uncertain about the steps in shifting gears.

DERAILLEUR ADJUSTMENT

Sometimes your rear derailleur needs adjustment. You may need to tighten the derailleur cable to remove excessive cable slack. Excessive slack in the cable will cause the derailleur to miss shift. Locate the Adjusting Barrel on the back of the derailleur.

Turn the barrel ANTI-CLOCKWISE half a turn and test the derailleur by changing gear.

Continue to turn the barrel until the chain is pitching correctly onto each gear.

NOTE: If you are not sure of these steps consult your bicycle retailer.

After the initial settling in period, if you have any adjustments that need attention, return to your bicycle retailer for advice.

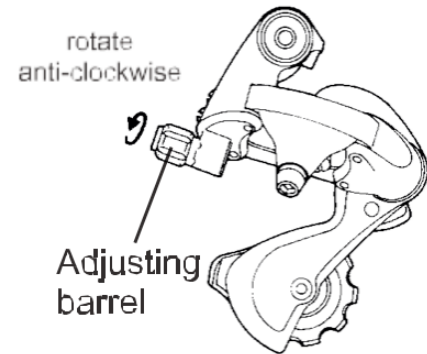

TOE CLIPS AND TOE STRAPS

Toe clips and straps are used to assist with the correct positioning of your feet on the pedals and to help your riding technique. The toe clip positions the ball of the foot over the pedal spindle, which gives maximum pedalling power. The toe strap, when tightened, keeps the foot engaged throughout the rotation cycle of the pedal.

Getting into and out of pedals with toe clips and straps requires skill which can only be acquired with practice. Do not ride in traffic or around other hazards until you can use toe clips and straps as a reflex action. Never ride in traffic with your toe straps tight.

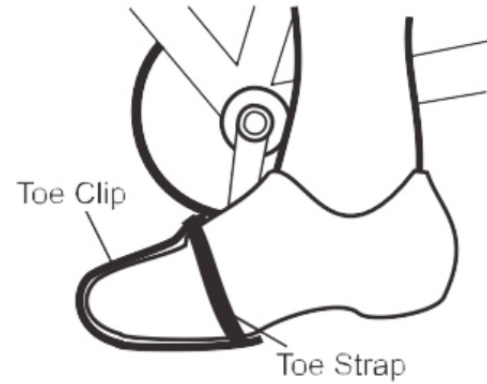

CLIPLESS PEDALS

Clipless pedals are usually adjustable. Your bicycle retailer can show you how to make this adjustment.



WARNING

Clipless pedals are intended for use with shoes specifically made to fit them and are designed to firmly keep the foot engaged with the pedal. Practice is required to learn to engage and disengage the foot safely

TYRES AND TUBES

Bicycle tyres are available in many designs and specifications, ranging from general purpose designs to tyres designed to perform best under very specific weather or terrain conditions. Your bicycle retailer can help you select the most appropriate tyre and tube.

The size and pressure rating of a tyre is marked

on the sidewall of the tyre. The part of this information which is most important to you is Tyre Pressure.

The best way to inflate a bicycle tyre to the correct pressure is with a bicycle pump. Your bicycle retailer can help you select an appropriate pump.



TAKE CARE

When using compressed air, over inflation can burst the tube and tyre. Never inflate a tyre beyond the maximum pressure marked on the sidewall of the tyre.

NOTE: *If the tyre pressure on your tyres is not in kilopascals please refer to the conversion table on Page 92.*

Tyre pressure is given either as maximum pressure or as a pressure range. How a tyre performs under different terrain or weather conditions depends largely on tyre pressure.

Inflating the tyre to near its maximum recommended pressure gives the lowest rolling resistance; but also produces the harshest ride. High pressures work best on smooth, dry pavement.

Very low pressures, at the bottom of the recommended pressure range, give the best performance on loose or muddy surfaces.

Riding with your tyres underinflated can cause a puncture, the tyre deforms and pinches the inner tube between the rim and the riding surface. Cornering with underinflated tyres can cause the tyre to roll off the rim resulting in a fall.

Ask your bicycle retailer to recommend the best tyre pressure for your kind of riding.

TYRE VALVES

There are two kinds of bicycle tube valves in common use - the Schraeder Valve and the Presta Valve. The bicycle pump you use must have the fitting appropriate to the valve stems on your bicycle.

The **Schraeder** is like the valve on a car tyre. To inflate a Schraeder valve tube with compressed air or with a bicycle pump, remove the valve cap and push the air hose or pump fitting on to the end of the valve stem. To let air out of a Schraeder valve, depress the pin in the end of the valve stem with the end of a key or other appropriate object.

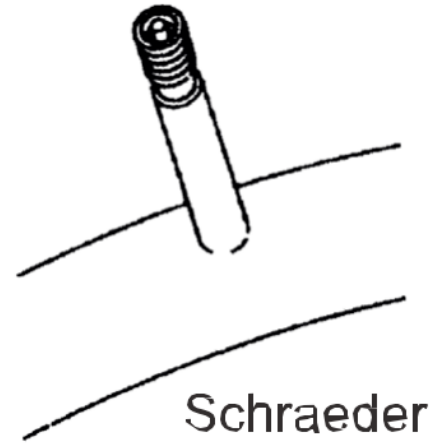

The **Presta** valve has a narrower diameter and is only found on bicycle tyres. To inflate a Presta valve tube using a Presta headed bicycle pump:

- remove the valve cap
- unscrew (anti-clockwise) the valve stem lock nut
- push down on the valve stem to free it up
- push the pump head on to the valve head, and inflate.

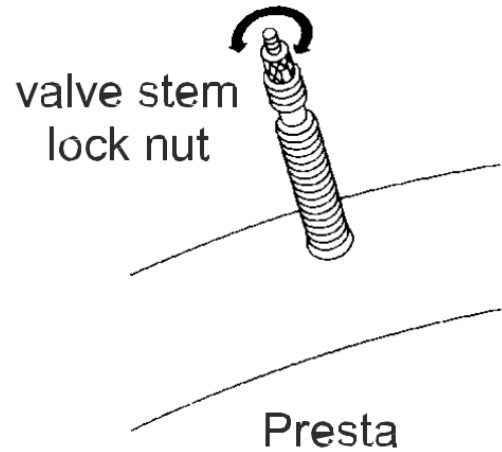

BICYCLE SUSPENSIONS

Some bicycles come equipped with suspension systems. There are many different types of suspension systems.

If your bicycle has a suspension system ask your bicycle retailer to explain care and use. Return your bicycle for regular maintenance and adjustment of the suspension system.

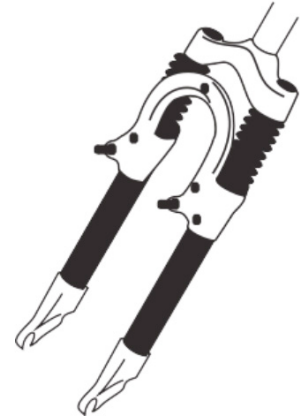

NOTE: Changing suspension adjustment can change the handling and braking characteristics of your bicycle. Read and follow manufacturer's instructions. Not all bicycles can be safely retrofitted with suspension systems. Check with your bicycle retailer.

3. MAINTAINING YOUR BICYCLE

SERVICE AND BASIC MAINTENANCE

Bicycles perform best when they are kept clean, lubricated and serviced regularly.

How much of your bicycle's service and maintenance you can do yourself depends on your level of skill and experience, and whether or

not you have the special tools required.

CLEANING

Mud and dust can be highly abrasive. Regular cleaning will help maintain your bicycle in good condition.

Always dry and lubricate your bicycle after washing to prevent rust.



WARNING

Some bicycle service and repair tasks require special knowledge and tools. Do not begin any adjustments or service on your bicycle if you have doubt about your ability. Unauthorised or incorrect service and repairs may void product warranty.

LUBRICATION

Keep your bicycle regularly lubricated for good performance and durability. Lubrication reduces friction and helps protect against rust.

All bearings and other moving parts require regular appropriate lubrication:

- Grease type lubrication:- bearings in head stem, wheels, bottom bracket and pedals (requires disassembly refer to your bicycle retailer).
- Oil type lubrication:- Brake and derailleur pivot points and jockey wheels, chain, free wheel.

For advice on appropriate special lubricants, ask your bicycle retailer.

4. MONTHLY SERVICE CHART

Monthly servicing of your bicycle is recommended. This consists of lubrication and adjustment of components.

Use the correct type of lubricants and tools, service the bicycle's components in logical groups and clean before you start.

TYRES AND TUBES

- Clean the tyres and inspect treads for wear.
- Remove any debris from tread or walls.
- Check tyre pressure is correct.
- Replace faulty tubes.

WHEELS

- Clean rims and check they are not dented or dimpled.
- Check rims for trueness and spokes for evenness of tension.
- Replace any bent or broken spokes.

CHAIN

- Check chain for excessive wear or stretching.
- Check for any stiff links.
- Use recommended lubricant.

BRAKES

- Check brake block and brake lever mounting bolts.
- Check brake blocks for wear. Replace if necessary.
- Check block toe-in is correct.
- Lubricate brake pivot bolts and adjust where necessary.

GEAR AND BRAKE CABLES

- Inspect all cable housing for damage. Replace if necessary.
- Clean and examine all cable wires for kinks and frayed ends. Replace if necessary.

- Adjust barrel adjusters and/or cable anchor bolts to compensate for cable stretch.

adjust cable tension at barrel adjusters and/or cable anchor bolts as required.

HUBS

- Check front and rear hub bearings for excess play or binding. Have adjustable cup-and-cone bearings, tightened or loosened if necessary.
- Check hubs are correctly lubricated.
- Tighten hub axle nuts and check quick release levers.

FRONT AND REAR DERAILLEURS

- Clean derailleur cages bushings.
- Check the accuracy of the indexing and

CRANK/CHAINRINGS AND FREEWHEELS

- Clean chainrings; check they are true and have no excessively worn, or broken teeth.
- Check crank arms are tight on bottom bracket spindle.
- Clean and lubricate freewheel and check for wear.
- Check freewheel sprockets for worn or broken teeth.

BOTTOM BRACKET/AXLE

- Test bottom bracket bearings for excess play or binding.
- Check that the locknut is tight.
- Check bottom bracket is correctly lubricated.

HEADSET

- Check headset for excess play or binding.
- Check the locknut is tight.

PEDALS

- Check pedal bodies are not cracked.
- If pedals are loose, tighten the mounting bolts firmly.
- Inspect toe clips/toe straps for damage.

GENERAL

- Check frame alignment and all the tubes for dents or damage.
- Check all bolts and nuts are secure. Tighten bolts with the correct tools.

CAUTION: Alloy bicycle parts can be damaged by overtightening.

STORAGE

The best protection for your bicycle is to store it under cover in a dry environment and away from corrosive materials such as battery acid and swimming pool chemicals. Thoroughly dry off your bicycle after use in wet conditions. Wax or lubricate as required.

Failure to follow this procedure may lead to rust and corrosion of metal work.

5. ADDITIONAL INFORMATION HELPFUL HINTS, SPECIAL INSTRUCTIONS AND WARRANTY

5.1 ABOUT YOUR BICYCLE RETAILER

Your bicycle retailer will help you to select bicycle

accessories for the kind of riding you wish to do. Bicycle shop staff have the knowledge, tools and experience to give you reliable advice and provide maintenance services. If you have a problem with your bicycle or your riding, talk to your bicycle retailer.

5.2 SPECIAL INSTRUCTIONS FOR CARE OF CARBON FIBRE BICYCLES

A carbon fibre frame requires special care due to the nature of its construction.

- Never clamp the bicycle using any of the carbon fibre frame tubes. Use the seat post to hold the frame during assembly.
- Do not use any solvents on the frame. Clean only with a mild detergent and water.

- Do not paint the frame.
- Avoid scratches and direct impacts to the frame. If you are involved in a mishap, or your bicycle is scratched during use, immediately see your bicycle retailer for inspection of the damage.
- Use a chain protector to lessen the chance of chipping the carbon fibre tubing.
- Use the manufacturer's recommended size seatpost and headset. Do not attempt to alter the original sizes of these parts.
- Avoid overtightening of the seatpost.
- Any other questions? Please contact your bicycle retailer.

5.3 TOOLS AND BICYCLE ASSEMBLY

Should you intend to undertake maintenance the following tools are considered to be the basic requirement:

- Adjustable wrench 5-10cm
- Adjustable wrench 32cm
- Flat screw driver 15mm
- Phillips head screw driver 15mm
- Allen Key set 2mm-6mm
- Set of open end spanners 7-17mm
- Set of tyre levers
- Chain link remover
- Wire cutters
- Torque wrench

All nuts and bolts should be checked on a regular basis for tightness. To assist in achieving the correct tension when tightening nuts and bolts the use of a torque wrench is recommended. Apply the following torque in Newton Metres (Nm) for the nominated parts of your bicycle:

Front Wheel Nuts	22-27 Nm
Rear Wheel Nuts	24-29 Nm
Seat Binder Nut	12-17 Nm
Seat Pillar Clamp Nut	4-19 Nm
Brake Anchor Nut	7-11 Nm
Handle Bar Clamp Nut	5-19 Nm
Head Stem Expander Bolt	17-19 Nm
Crank Cotter Pin Nuts	5-10 Nm
Brake Centre Bolt	5-7 Nm
Pedals	35-40 Nm

The following checklist presumes a bicycle which is assembled except for the handlebar & stem, brake and gear levers, saddle and seat stem, pedals, frame reflectors and wheels.

- Fit wheels to frame and align. Secure axle nuts or Quick Release (QR) mechanism.
- Lubricate handlebar stem, slacken wedge bolt and wedge, slide into head set to below minimum insert mark, align square to front wheel, tighten wedge bolt. Tighten wedge bolt. Check head stem lock nut is tight and that the handlebar will not rotate.
- If your bicycle is equipped with a 'threadless' headset, check fitting adjustments with your bicycle retailer. DO NOT OVER TIGHTEN the two securing bolts.
- Slide brake and gear lever assemblies onto handlebar in correct configuration. Tighten locking bolts. Adjust brake assembly cables and align brake blocks for prescribed clearance.
- Fit handlebar tape or handgrips, stop ends to bar if bar is taped, and bell.
- Assemble saddle onto seat stem. Tighten fixing nuts.
- Lubricate seat stem and insert in seat tube to below minimum insert mark. Tighten seat binder bolt or Quick Release mechanism.
- Fit pedals to crank in correct order; pedal marked R on the right hand side; L on the left.

- Fit frame mounted reflector brackets and reflectors.
- Align reflectors to vertical. Tighten all bolts. Confirm that wheel reflectors are fitted.
- Recheck that all components are correctly assembled, all bolts, nuts and QR correctly secure. Check that handlebar and saddle cannot be swivelled sideways.
- Check derailleur gears/hub gears for correct operation; adjust to manufacturer's specification. Check both brakes for correct operation.

WARNING



If you are unsure about correct assembly and/or adjustment, seek advice from a qualified bicycle mechanic.

'Threadless' head sets: some bicycles, especially those equipped with a front fork suspension system, are fitted with a 'threadless' head set. Special tools and/or procedures may be required to correctly secure such devices.

5.4 LOCK YOUR BICYCLE

If you lock up your bicycle, it is much less likely to be stolen. Nearly all bicycles stolen were not locked at the time.

Lock your bicycle to something solid e.g. a tree, a parking meter or a post. Make sure the bicycle cannot be lifted from the post or the post lifted out of the ground or pavement. Use a good quality U-Lock.

A good quality, hardened steel U-lock is your bicycle's best protection from theft. U-locks are more secure than cables or chains with padlocks. Combination locks provide least security.

Make sure the lock or cable is not in a position which makes it easy to be removed or cut.

- A front wheel with Quick Release can be removed and locked to the frame.
- A good quality U-Lock may be the most secure device for locking your bicycle.
- Bicycle parking rails should comply with Australian Standard AS2890.3 (1993).
- Refer to Guide to Traffic Engineering Practice Part 14 - Bicycles (AUSTROADS 1999).
- **www.bikeoz.com.au** - provides additional information.
- **www.cyclingpromotion.com.au** - helping you get more out of your riding.

5.5 KEEP A RECORD OF YOUR BICYCLE

Take a colour photograph of your bicycle, write the frame number on the back of the photograph and keep it in a safe place. Less than one in ten stolen bicycles is returned, partly because the owner cannot describe the bicycle. Engraving a registration number on the bicycle will also help. The police, Neighbourhood Watch and service clubs run bicycle registration programs.

If you keep a record of the details of your bicycle it will greatly increase the possibility of getting it back should it be lost or stolen.

Remember the advice about LOCKING YOUR BICYCLE. **A good quality lock is cheap insurance.**

See the record chart at end of this manual.

TROUBLESHOOTING CHART

PROBLEM	POSSIBLE CAUSE	REMEDY
Frequent punctures	Inner tube old or faulty	Replace inner tube"
	Tyre tread / casing worn	Replace tyre
	Tyre unsuited to rim	Replace with correct tyre
	Tyre not checked after previous puncture	Remove sharp object embedded in tyre
	Tyre pressure too low	Correct tyre pressure
	Spoke protruding into rim	File down spoke
When applying the brakes they squeal / squeak	Brake blocks worn down	Replace blocks
	Brake block toe-in incorrect	Correct block toe-in
	Brake blocks / rim dirty or wet	Clean blocks and rim
	Brake arms loose	Tighten mounting bolts

TROUBLESHOOTING CHART

PROBLEM	POSSIBLE CAUSE	REMEDY
Brakes not working effectively	Brake blocks worn down	Replace brake blocks
	Brake blocks or rims greasy, wet or dirty	Clean blocks and rims
	Brake cables are binding / stretched / damaged	Clean / adjust / replace cables
	Brake levers are binding	Adjust brake levers
	Brakes out of adjustment	Centre brakes
Steering not accurate	Wheels not aligned	Align wheels correctly
	Headset loose or binding	Adjust / tighten headset
	Front forks or frame bent	Seek advice at a bicycle shop

TROUBLESHOOTING CHART

PROBLEM	POSSIBLE CAUSE	REMEDY
Knocking or shuddering when applying the brakes	Bulge in the rim or rim out of true	True wheel or take rim to a bicycle shop for repair*
	Brake mounting bolts loose	Tighten bolts
	Brakes out of adjustment	Centre brakes and / or adjust brake block toe-in
	Disk brakes: disk may be bent or blocks not free	Seek advice at a bicycle shop
	Forks loose in head tube	Tighten headset
Wobbling wheel	Axle broken	Replace axle
	Wheel out of true	True wheel
	Hub cones loose	Adjust hub bearings
	Headset binding	Adjust headset

* Repair of damaged front wheel rim not recommended. Replace wheel rim.

TROUBLESHOOTING CHART

PROBLEM	POSSIBLE CAUSE	REMEDY
Gear shifts faulty	Derailleur cables sticking stretched / damaged	Lubricate / tighten / replace cables
	Front or rear derailleur not adjusted properly	Adjust derailleurs
	Indexed shifting not adjusted properly	Adjust indexing
Slipping chain	Excessively worn / chipped chainring or freewheel	Replace chainring, sprockets and chain
	Chain worn / stretched	Replace chain
	Stiff link in chain	Lubricate or replace link
	Non compatible chain / chainring / freewheel	Seek advice at a bicycle shop

TROUBLESHOOTING CHART

PROBLEM	POSSIBLE CAUSE	REMEDY
Chain jumping off	Chainring bent	Replace Chainring
	Chainring loose	Tighten mounting bolts
	Chainring teeth bent or broken	Replace Chainring
	Rear or front derailleur side-to-side travel out of adjustment	Adjust derailleur travel
Constant clicking noises when pedalling	Stiff chain link	Lubricate or replace link
	Loose pedal spindle / bearings	Adjust bearings / spindle nut
	Loose bottom bracket spindle / bearings	Adjust bottom bracket
	Bent bottom bracket / pedal spindle	Replace bottom bracket / spindle
	Loose crank	Tighten crank bolt

TROUBLESHOOTING CHART

PROBLEM	POSSIBLE CAUSE	REMEDY
Grinding noise when pedalling	Pedal bearings too tight	Adjust bearings
	Bottom bracket bearings too tight	Adjust bearings
	Chain fouling derailleurs	Adjust chain line
	Derailleur jockey wheels dirty / binding	Clean and lubricate jockey wheels
Freewheel does not freewheel	Freewheel internal pawl pins are jammed	Lubricate. If problem persists, replace freewheel

NOTE: Regular maintenance by your bicycle retailer is recommended

KILOPASCAL FROM PSI CONVERSION TABLE

PSI	BAR	KPA
35	2.4	241
40	2.8	276
45	3.1	310
50	3.5	345
55	3.8	379
60	4.1	414
65	4.5	448
70	4.8	483
75	5.2	517
80	5.5	552
85	5.9	586
90	6.2	621
95	6.6	655

PSI	BAR	KPA
100	6.9	689
105	7.2	724
110	7.6	758
115	7.9	793
120	8.3	827
125	8.6	862
130	9.0	896
135	9.3	931
140	9.7	965
145	10.0	1000
150	10.3	1034
155	10.7	1069
160	11.0	1103

OWNER'S MANUAL DISCLAIMER

**THE INFORMATION CONTAINED IN THIS MANUAL
COMPLIES WITH RELEVANT AUSTRALIAN AND NEW
ZEALAND STANDARDS AT THE TIME OF PRINTING.**

**THIS MANUAL MAY NOT BE REPRODUCED WITHOUT THE
WRITTEN PERMISSION OF BIA LTD.**

WARRANTY INFORMATION

It is the responsibility of the supplier of your bicycle to include with this Owner's Manual all relevant **WARRANTY** details.

Proof of ownership may be required before warranty provisions can be processed.

YOUR CONSUMER RIGHTS:

White pages telephone directories list State and Territory consumer and fair trading office numbers.

Key words:

CONSUMER AFFAIRS / FAIR TRADING

Government web sites provide extensive information. Check these sources

Warranty enquiries should be made to the point of sale (the retailer) in the first instance.

WARRANTY

THE ELECTRIC BICYCLE CO ELECTRIC BICYCLES, TRICYCLES and SCOOTERS

This Warranty is given by:

THE ELECTRIC BICYCLE CO PTY LTD ACN 007 066 319 (“The Electric Bicycle Co”)

PO Box 2014 Parkdale VIC Australia 3195

Phone: (03) 9584 3000

Email: info@electricbicycle.com.au

The Electric Bicycle Co warrants to the original purchaser (“Purchaser”) of bicycles, tricycles, scooters and or parts from The Electric Bicycle Co (“TEBCO Product”) that this TEBCO Product when used for normal riding purposes is free

from defects in workmanship and materials (the “Warranty”).

1. TERM OF WARRANTY AND ITEMS COVERED

The Warranty extends to the specific TEBCO Product purchased by the Purchaser for the following period from the date of purchase:

- a. The frame of the bicycle, tricycle or scooter for a period of two years;
- b. The mechanical and electrical components (including but not limited to the motor, charger and circuit boards) for a period of twelve months; and

WARRANTY

2. NOTICE

- 2.1** The Electric Bicycle Co bicycle, The Electric Bicycle Co tricycle and The Electric Bicycle Co scooter are designed and intended only for the purpose of normal riding and they are specifically not designed or intended for off-road riding or any other uses including but not limited to jumping, stunt riding or racing.
- 2.2** To the greatest extent permitted by law and subject to the Warranty, the Electric Bicycle Co shall not be liable for any loss, damage, cost, injury, harm and expense of any kind (including without limitation, consequential loss) arising from the use or supply of the

TEBCO Product to the Purchaser. The Purchaser agrees to exclude all warranties implied by law which may lawfully be excluded.

- 2.3** The Electric Bicycle Company accepts to the extent set out in the clauses herein, liability for all warranties implied under the Australian Consumer Law (set out in Schedule 2 to the Australian Competition and Consumer Act 2010 (Cth)) or under any other legislation the effect of which cannot be lawfully excluded. All warranties and conditions that are capable of exclusion (save for those expressly contained in the clauses herein) are expressly excluded.

WARRANTY

3. EXCEPTIONS TO WARRANTY

2.1 The Warranty does not apply where a TEBCO Product:

- a.** has been used in a way for which it was not designed or intended to be used as set out in clause 2.1 above;
- b.** has been used for hire, rental or any other commercial purpose;
- c.** has been modified or changed since its original supply by The Electric Bicycle Co;
- d.** fails due to an accident, abuse or neglect, or in the case of battery, due to failure to comply strictly with The Electric Bicycle Co's instructions on battery usage.;
- e.** does not consist solely of original TEBCO Product parts or equipment; or
- f.** is defective or fails as a result, directly or indirectly, from a person (other than a person explicitly authorised by The Electric Bicycle Co) attempting to repair, maintain or service a TEBCO Product, or adjusting or failing to adjust any TEBCO Product requiring normal maintenance and service.

3.2 The Warranty does not apply to wheels, tyres or tubes.

3.3 Warranty extends only to the Purchaser and only if the TEBCO Product was purchased

WARRANTY

from a person authorised by The Electric Bicycle Co to sell the TEBCO Product (“Dealer”). The Warranty may not be transferred by the Purchaser to any other person.

4. HOW TO CLAIM UNDER THIS WARRANTY

4.1 To claim under this warranty, the Purchaser must deliver, at its own cost, the TEBCO Product and proof of purchase to the Dealer from which the TEBCO Product was purchased or to the address above, together with the following information:

- g.** The brand, model and serial number of the TEBCO Product;
 - h.** The date, place and name of the Dealer from which the TEBCO Product was purchased;
 - i.** Details of the defect or failure in respect of which the claim under the warranty is made; and
 - j.** Written reasons why the Purchaser believes it is entitled to claim under the warranty provided herein.
- 4.2** Where the Warranty does apply to the TEBCO Product, The Electric Bicycle Co shall (at its option) repair the relevant TEBCO Product or replace the relevant TEBCO Product with a comparable product or part without charge.

WARRANTY

4.3 In the event that the TEBCO Product is not defective within the terms of this Warranty, all reasonable costs and expenses relating to the processing of the claim under the warranty shall be borne by the Purchaser.

5. AUSTRALIAN CONSUMER LAW

5.1 Our goods come with guarantees that cannot be excluded under the Australian Consumer Law. You are entitled to a replacement or refund for a major failure and compensation for any other reasonably foreseeable loss or damage. You are also entitled to have the goods repaired or replaced if the goods fail to be of acceptable quality and the failure does not amount to a major failure.

5.2 The benefits given to the Purchaser under this Warranty are in addition to other rights and remedies of the Purchaser under the Australian Consumer Law and other applicable laws.

5.3 While this Warranty applies to the original Purchaser only, subsequent purchasers may have rights under the Australian Consumer Law.

Battery Warranty Terms and Conditions

The battery's performance is covered by the following warranty terms: it is guaranteed to retain at least 80% of its capacity after 1 year and 60% after 2 years from the date of purchase, specifically for private use.

WARRANTY

TEBCO, herein referred to as the manufacturer, commits to rectify or replace any product that it has supplied to you at its own expense in cases where the product's performance deviates from the TEBCO specifications during the designated 24-month warranty period due to manufacturer faults.

The standard warranty period starts on the date of product delivery or collection. In cases where delivery proof is absent, the product delivery date is presumed to be 3 business days after the product's dispatch date.

To request service under the warranty, valid proof of purchase (such as an invoice or paid order confirmation) must be provided.

TEBCO's approval is mandatory for any repair service covered by the warranty. Unauthorized repairs undertaken by customers will render the warranty null and void.

When products are initially defective or damaged upon delivery, photographic evidence of the damage must be submitted via email to TEBCO before any repair or replacement of the battery can be carried out as per these stipulated terms.

TEBCO retains the right to substitute the faulty battery with an identical one instead of repairing it. In cases of replacement, TEBCO will select, at its discretion, the most closely matching battery from its existing range of products. This

WARRANTY

replacement battery might vary in specifications from the original, as battery specifications can change over time. Replacing the battery does not extend or restart the warranty period.

Should TEBCO be unable to repair or replace the battery, customers will be offered a credit or a refund for the product's purchase price (as chosen by TEBCO). This credit or refund will exclude any associated delivery costs.

Upon receipt of goods from TEBCO, customers are responsible for inspecting them for any damage. If damage due to transit is identified, it must be reported to TEBCO within 3 days of receiving the product. Failure to report such damage within this timeframe could result in the

denial of warranty claims for physical damage.

While in transit to and from the TEBCO Authorized Repair Centre, the product is at the customer's risk.

TEBCO reserves the right to seek reimbursement for any incurred costs if the product is found to be in proper working condition or if it's determined that the warranty conditions do not apply or have been violated.

TEBCO maintains the reasonable discretion to assess whether a battery is performing in line with TEBCO specifications and industry norms, in accordance with applicable law.

WARRANTY

This warranty is non-transferable to subsequent owners of products originally purchased from TEBCO.

To the extent allowed by law, the warranty will not be applicable to a battery if:

- The product hasn't been installed, operated, maintained, or used as per the manufacturer's instructions or specifications.
- The factory-applied serial number has been altered or removed.
- Damage, malfunction, or failure arises from alterations (hardware or software), accidents, misuse, abuse, fire, liquid spillage, mis-adjustment of customer controls, incorrect voltage usage, power fluctuations, natural disasters, voltage supply issues, tampering, unauthorized repairs, use of defective or incompatible accessories, computer virus operation, exposure to corrosive conditions, or entry by foreign objects.
- Damage occurs during transportation, installation, or relocation of the product.
- Third-party software or hardware not included in the original product configuration is involved.
- Defective pixels (dead or stuck) appear in digital products.

WARRANTY

- The failure is not related to the product's performance in line with its specifications
- Service or support for software, operating systems, or applications installed on the product is sought, except for restoring factory default settings.
- Service is requested for a product located outside of China.

To the fullest extent permissible by law:

- TEBCO shall not be held liable for loss, damage, or changes to third-party hardware, software, programs, data, or information stored on any media or part of the product, regardless of the cause.

- TEBCO shall not be held liable for loss of use, profit, revenue, or any resulting indirect or consequential loss or damage.
- TEBCO's total liability for all warranty claims shall not exceed the original product purchase price or, at TEBCO's discretion, the replacement of the product with an equivalent one.
- All other warranties, conditions, terms, representations, and undertakings, whether explicit or implied, are excluded by TEBCO.

BATTERY DISCLAIMER

IF ELECTRIC BICYCLE IS NOT USED REGULARLY, THEN THE BATTERY MUST BE RE-CHARGED EVERY MONTH.

FAILURE TO RE-CHARGE BATTERY REGULARLY CAN LEAD TO SEVERE DEGRADATION OF BATTERY.

NEGLIGENCE IN THIS MATTER MAY VOID WARRANTY.

**FOR REPLACEMENT BATTERIES –
CONTACT TEBCO DIRECTLY
ON 03 9584 3000**

NOTES

*the future
is electric!*

TEBCO

THE ELECTRIC BICYCLE CO.